

HAITIAN PLASTICS MACHINERY GROUP CO., LTD  
 No.1688, Haitian Road, Xiaogang, Beilun, Ningbo, Zhejiang,  
 China 315801  
 + 86-574-8617 7005 (China)  
 + 86-574-8617 7242 (International)  
 haitian@mail.haitian.com  
 www.haitianpm.com

NINGBO HAITIAN HUAYUAN MACHINERY CO.,LTD.  
 No.1, Nanhuan Road, Export Processing Zone, Beilun,  
 Ningbo, Zhejiang, 315806 P.R. China  
 +86-574-8617 7242  
 +86-574-8622 1864  
 haitian@mail.haitian.com  
 www.haitianpm.com

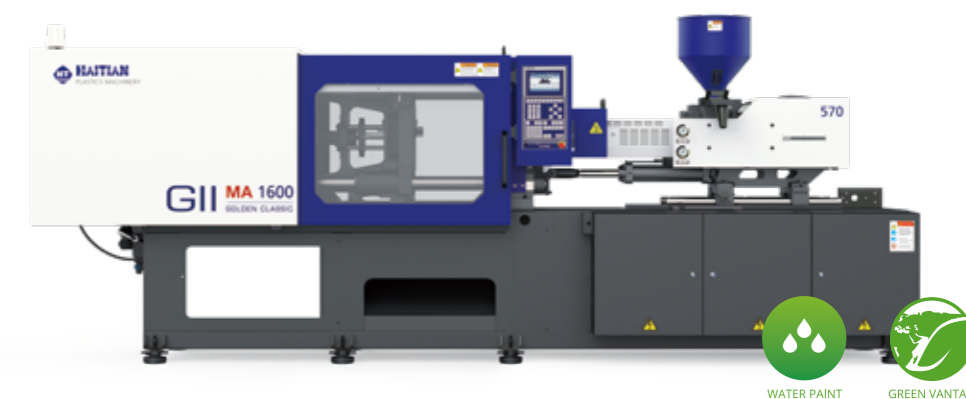

## HAITIAN MA/GII SERIES

Specifications  
 860 - 10,000 kN



# SPECIFICATION

TECHNICAL DATA  
MACHINE TYPE

		MA860/280GII			MA1200/400GII			MA1600/570GII			MA2000/770GII		
		A	B	C	A	B	C	A	B	C	A	B	C
<b>INJECTION UNIT</b>													
Screw diameter	mm	32	36	40	36	40	45	40	45	50	45	50	55
Screw L/D ratio		22.5	20	18	23.3	21	18.7	22.5	20	18	22.2	20	18.2
Injection volume (theoretical)	cm <sup>3</sup>	120	152	188	173	213	270	252	319	394	365	451	546
Injection weight (PS)	g	109	138	171	157	194	246	229	290	359	332	410	497
Injection rate	g/s	74	94	116	93	115	146	112	141	175	152	187	227
Injection pressure	MPa	237	187	151	231	187	147	226	178	145	213	172	142
Plasticizing rate (GPPS) ①	g/s	9.9	11.3	13.9	10.4	12.7	16.5	13.8	17.7	21.1	17.5	21.0	25.9
Plasticizing rate (HDPE) ②	g/s	-	-	-	-	-	-	-	-	-	-	-	-
Screw speed	rpm	0-235			0-215			0-205			0-175		
<b>CLAMPING UNIT</b>													
Clamping force	kN	860			1200			1600			2000		
Mold opening stroke	mm	310			350			420			470		
Dist. between tie bars (HxV)	mm	360x360			410x410			470x470			510x510		
Mold height max.	mm	360			430			500			510		
Mold height min.	mm	150			150			180			200		
Ejector stroke	mm	100			120			140			140		
Ejector force	kN	33			33			33			62		
<b>OTHERS</b>													
Pump motor power	kW	13			15			18.5			22		
Heater power	kW	8.1			11.75			11.75			16		
Machine dimension (LxWxH)	m	4.11x1.14x1.97			4.58x1.21x1.98			4.91x1.31x2.0			5.43x1.37x2.16		
Machine weight	t	3			4.1			4.9			6.3		
Hopper capacity	kg	25			25			50			50		
Oil tank	l	130			155			185			235		

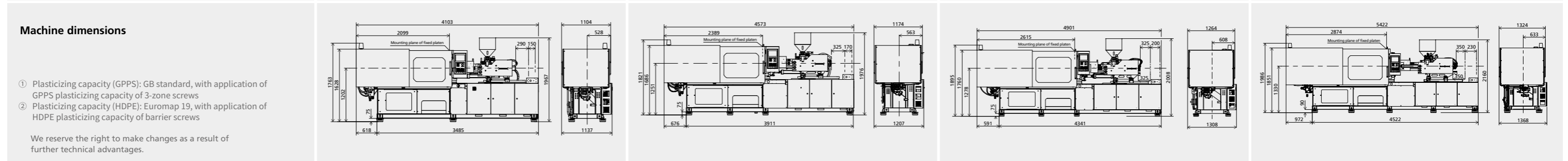
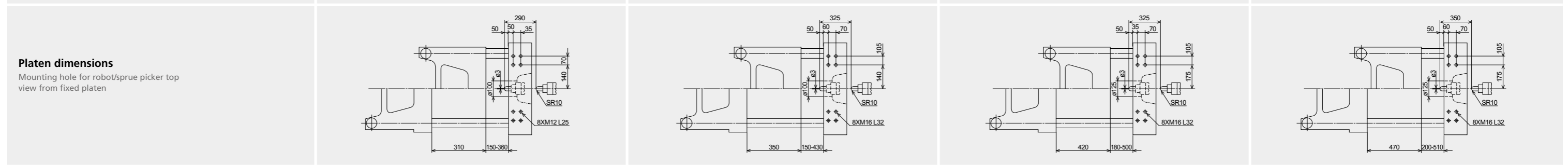
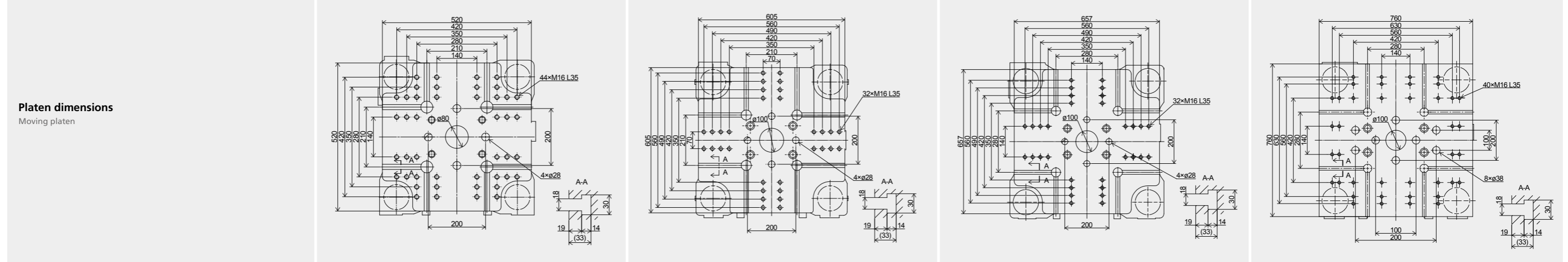

# SPECIFICATION

TECHNICAL DATA  
MACHINE TYPE

		MA2500/1000GII			MA3000/1800GII			MA3600/2250GII			MA4500/3200GII		
		A	B	C	A	B	C	A	B	C	A	B	C
<b>INJECTION UNIT</b>													
Screw diameter	mm	50	55	60	60	65	70	65	70	80	70	80	90
Screw L/D ratio	L/D	22	20	18.3	21.7	20	18.6	21.5	20	17.5	22.9	20	17.8
Injection volume (theoretical)	cm <sup>3</sup>	496	601	715	848	995	1154	1068	1239	1618	1423	1859	2353
Injection weight (PS)	g	452	546	650	771	905	1050	972	1127	1472	1295	1692	2141
Injection rate	g/s	173	209	249	241	283	328	316	366	478	351	459	580
Injection pressure	MPa	213	176	148	211	181	155	203	176	135	226	174	137
Plasticizing rate (GPPS) ①	g/s	21.6	26.6	30.3	32.8	37.2	43.7	40.4	47.4	62	48.8	63.9	78.2
Plasticizing rate (HDPE) ②	g/s	-	-	-	59.2	66.6	77.7	72.5	86.3	109	85.6	115	150
Screw speed	rpm	0-175			0-185			0-190			0-185		
<b>CLAMPING UNIT</b>													
Clamping force	kN	2500			3000			3600			4500		
Mold opening stroke	mm	540			600			660			740		
Dist. between tie bars (HxV)	mm	570x570			660x660			710x710			780x780		
Mold height max.	mm	570			660			710			780		
Mold height min.	mm	220			250			250			330		
Ejector stroke	mm	150			160			160			200		
Ejector force	kN	62			62			110			110		
<b>OTHERS</b>													
Pump motor power	kW	30			37			45			55		
Heater power	kW	18.6			25.45			31.3			39.2		
Machine dimension (LxWxH)	m	6.04x1.46x2.22			6.67x1.80x2.38			7.09x1.80x2.34			7.92x1.95x2.55		
Machine weight	t	7.8			11.3			14.7			18.8		
Hopper capacity	kg	50			50			50			50		
Oil tank	l	270			420			510			630		

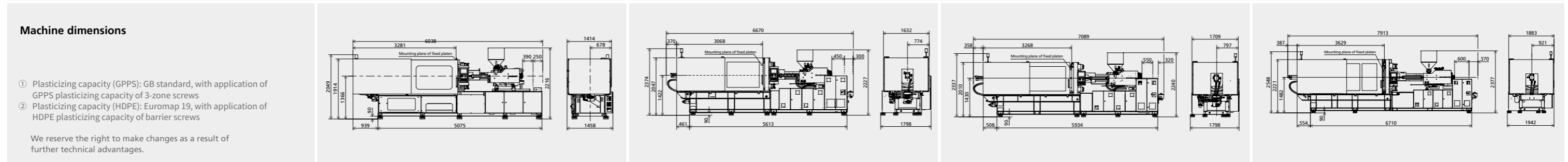
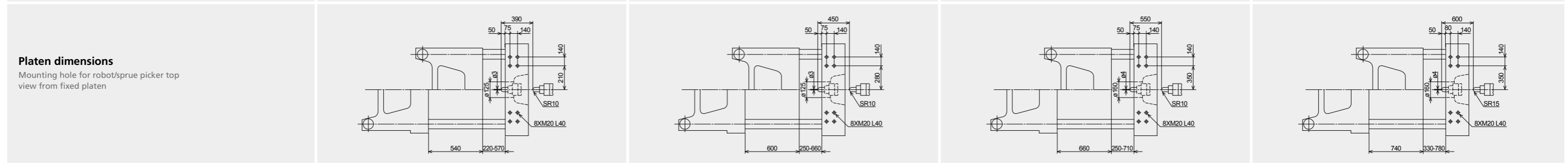
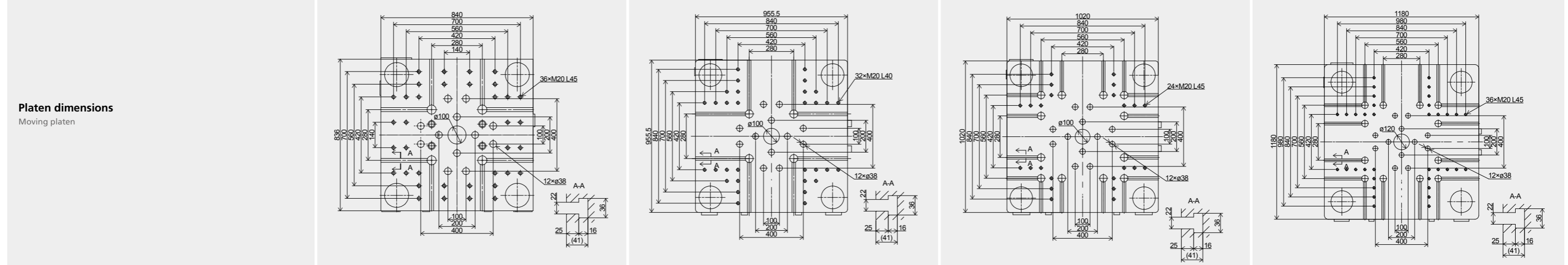

- ① Plasticizing capacity (GPPS): GB standard, with application of GPPS plasticizing capacity of 3-zone screws
- ② Plasticizing capacity (HDPE): Euromap 19, with application of HDPE plasticizing capacity of barrier screws

We reserve the right to make changes as a result of further technical advantages.

# SPECIFICATION

TECHNICAL DATA  
MACHINE TYPE

		MA5300/4000GII				MA6500/4550GII				MA7800/6350GII				MA10000/7950GII			
		A	B	C	D	A	B	C	D	A	B	C	D	A	B	C	D
<b>INJECTION UNIT</b>																	
Screw diameter	mm	80	85	90	100	80	90	100	110	90	100	110	120	100	110	120	130
Screw L/D ratio	L/D	22	20.7	19.6	17.5	24.8	22	19.8	18	24.4	22	20	18.3	24.2	22	20.2	18.6
Injection volume (theoretical)	cm <sup>3</sup>	2211	2496	2799	3455	2211	2799	3455	4181	2799	3455	4181	4976	3769	4561	5428	6371
Injection weight (PS)	g	2012	2272	2547	3144	2012	2547	3144	3805	2547	3144	3805	4528	3430	4151	4940	5797
Injection rate	g/s	454	513	575	710	427	540	667	808	567	700	847	1008	653	790	940	1104
Injection pressure	MPa	199	176	157	127	226	178	144	119	224	182	150	126	217	179	151	128
Plasticizing rate (GPPS) ①	g/s	64.7	71.6	81.4	99.4	75.7	95	117	137	89.5	110	130	152	104	125	145	167
Plasticizing rate (HDPE) ②	g/s	94	104	118	145	112	142	175	206	132	162	193	224	152	182	107	239
Screw speed	rpm	0-145				0-131				0-136				0-108			
<b>CLAMPING UNIT</b>																	
Clamping force	kN	5300				6500				7800				10000			
Mold opening stroke	mm	825				900				980				1120			
Dist. between tie bars (HxV)	mm	830x800				895x895				980x980				1090x1090			
Mold height max.	mm	850				900				980				1100			
Mold height min.	mm	350				400				400				500			
Ejector stroke	mm	200				260				260				320			
Ejector force	kN	158				186				186				215			
<b>OTHERS</b>																	
Pump motor power	kW	70				85				30+70				37+70			
Heater power	kW	45.7				54.3				67.8				81			
Machine dimension (LxWxH)	m	9.06x2.07x2.67				10.07x2.20x2.73				10.72x2.29x2.75				11.87x2.42x2.86			
Machine weight	t	23				30.2				36				47.5			
Hopper capacity	kg	100				100				100				100			
Oil tank	l	750				880				1000				1150			

